

LINVISIBILE®



Linvisibile

Linea External Sliding door

**TECHNICAL DATA
AND ASSEMBLY INSTRUCTION**

TECHNICAL SPECIFICATION

LINVISIBLE MAREA - EXTERNAL SLIDING DOOR LINEA VERSION is the exclusive system equipped with a guide for the sliding movement of doors and leaves, made of:

Guide support frame in wood and extruded aluminum alloy EN AW 6060 (Anticorodal 063) which guarantees perfect anchoring of the aluminum to the false ceiling and makes it paintable with good quality water-based paints, enamels, etc .. Available in a wide range of size. The high solidity of the guide support frame prevents even the slightest bending, preserving it from the risk of unpleasant cracking and detachment of the plaster and / or the finish of the false ceiling.

High performing removable sliding guide with high flow rates.

Panel composite by:

- 8 mm tempered glass plate (4 + 4 mm if stratified) available in different typologies: transparent, also with mesh, retro-lacquered, frosted, mirrors;
- anodized perimetric aluminum frame, to choose between 7 colours, or matt lacquered, of 50 mm thick, containing the glass plate;

Lower **directional system** to keep the door centre line aligned when the leaf slides, which guarantees high panel stability and avoids sideways 'oscillation' when the panel moves.

OPENING TYPES

OPENING TO THE LEFT

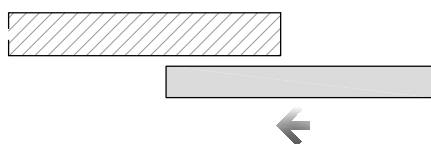
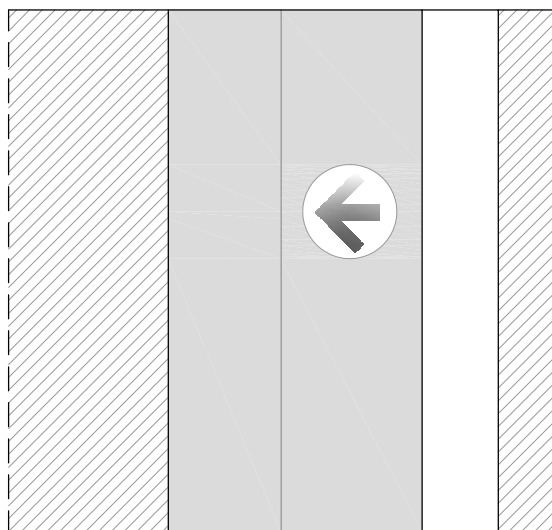

OPENING TO THE RIGHT

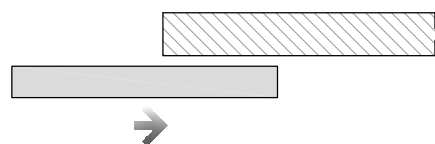
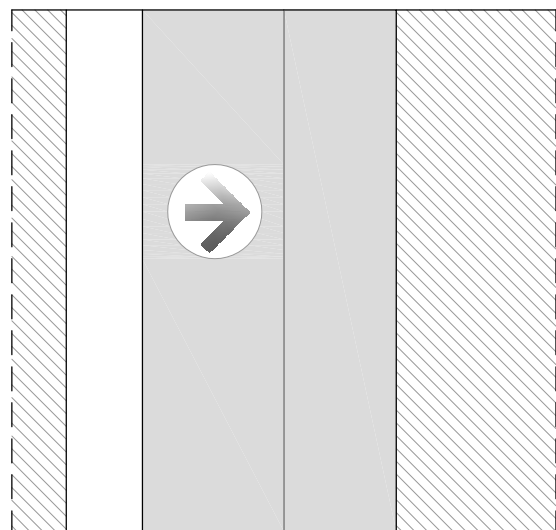

APPLICATION WITH LATERAL WALL

VERTICAL SECTION
AT THE CLEAR WIDTH
 (EXAMPLE OPENING TO THE RIGHT)
 SCALE 1:5

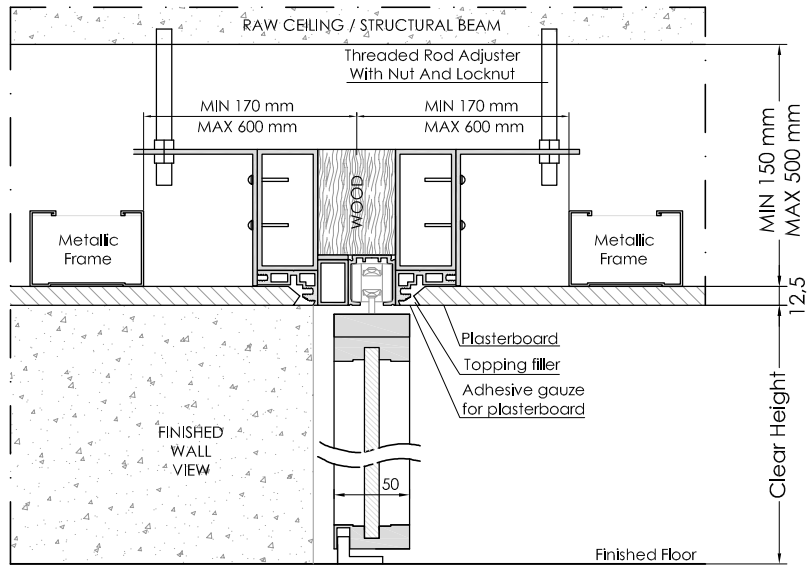

EXAMPLE OF CLOSING CONTINUOUSLY TO THE WALL

HORIZONTAL SECTION
OPENING TOWARD RIGHT

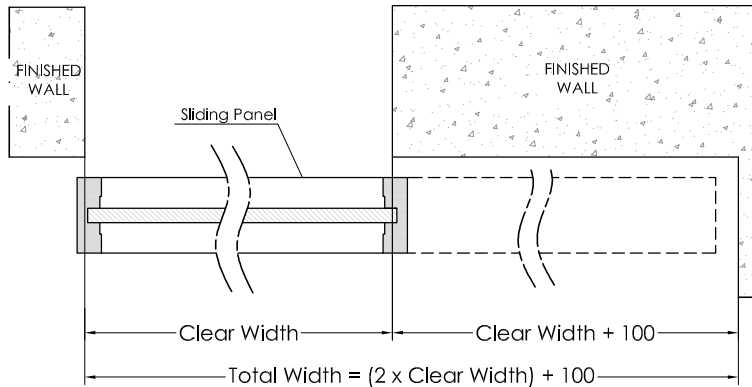

VERTICAL SECTION

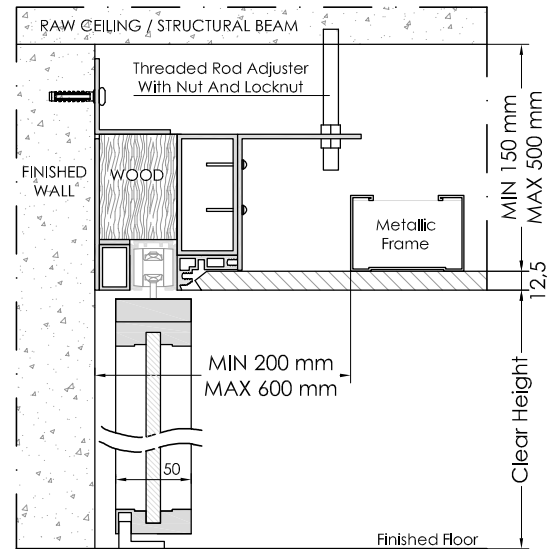

EXAMPLE OF PERPENDICULAR CLOSING TO THE WALL

HORIZONTAL SECTION
OPENING TOWARD LEFT

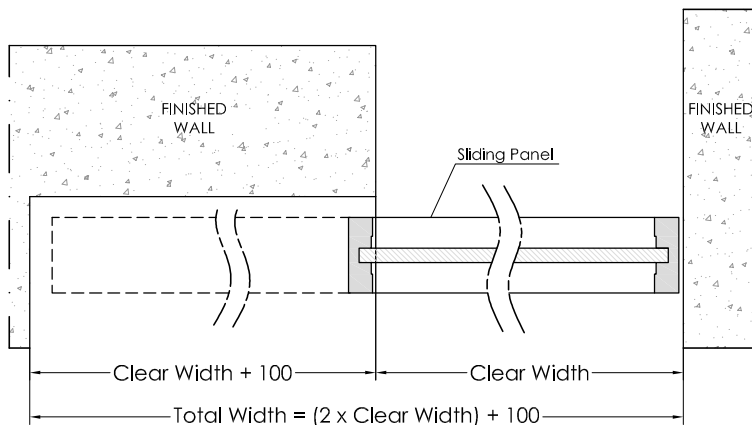

VERTICAL SECTION

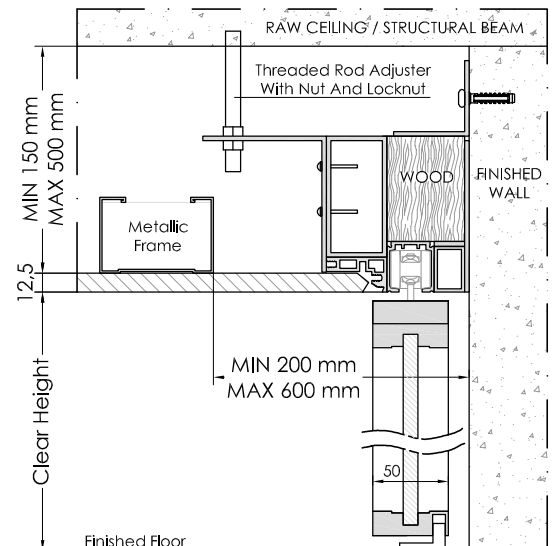

These documents are the property of Portarredo s.r.l. and are protected by Italian as well as international laws, treaties and agreements on intellectual property. They may not be copied, reproduced, translated or transcribed in any form whatsoever, in whole or in part, without the prior written authorisation of Portarredo s.r.l.

Maximum attention has been paid to these documents before printing. However, because of continuous technological development and since we are constantly engaged in the development and improvement of our product range, we reserve the right to modify specifications of any product without prior notice.

